

**FEATURES**

- \* 0.56 inch (14.22 mm ) DIGIT HEIGHT
- \* EXCELLENT SEGMENT UNIFORMITY
- \* LOW POWER REQUIREMENT
- \* HIGH BRIGHTNESS AND HIGH CONTRAST
- \* WIDE VIEWING ANGLE
- \* SOLID STATE RELIABILITY
- \* BINNED FOR LUMINOUS INTENSITY

**DESCRIPTION**

The LSHD-5503 is a 0.56 inch (14.22 mm) digit height single-digit display. This device uses AS-AlInGaP RED LED chips (AlInGaP epi on GaAs substrate). The display has light gray face and white segments.

**DEVICE**

<b>PART NO.</b>	<b>DESCRIPTION</b>
AlInGaP RED	Common Cathode
LSHD-5503	Rt. Hand Decimal

## PACKAGE DIMENSIONS

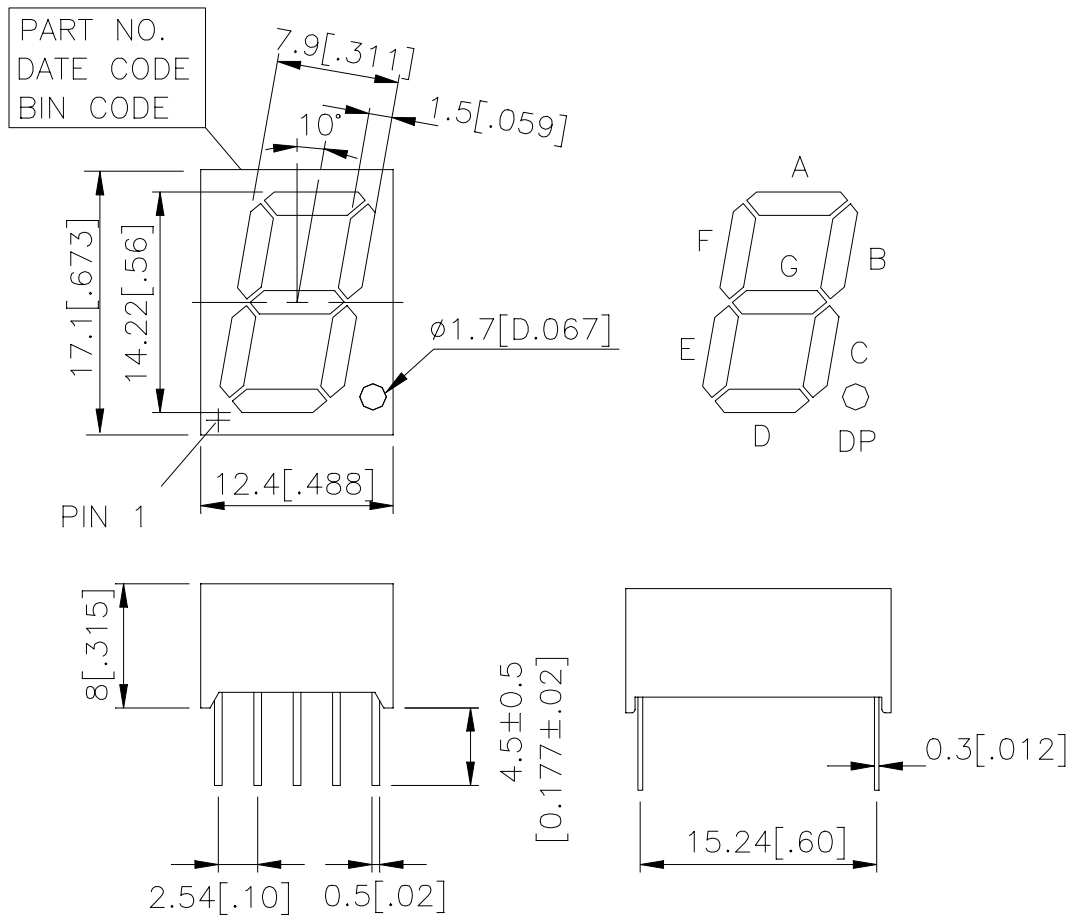

NOTES: All dimensions are in millimeters. Tolerances are  $\pm 0.25\text{mm}$  (0.01") unless otherwise noted.

## INTERNAL CIRCUIT DIAGRAM

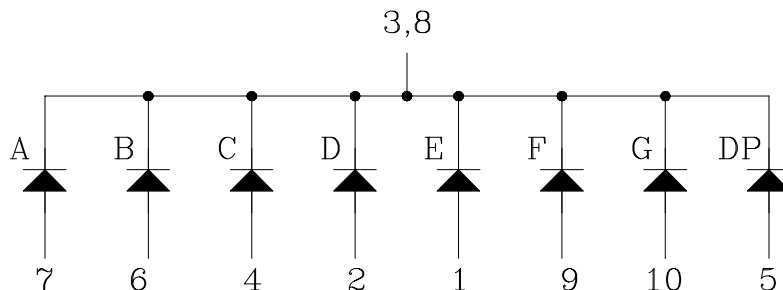

**PIN CONNECTION**

<b>No.</b>	<b>CONNECTION</b>
1	Anode E
2	Anode D
3	Common Cathode
4	Anode C
5	Anode DP
6	Anode B
7	Anode A
8	Common Cathode
9	Anode F
10	Anode G



# LITE-ON TECHNOLOGY CORPORATION

Property of Lite-On Only

## ABSOLUTE MAXIMUM RATING AT Ta = 25°C

PARAMETER	MAXIMUM RATING	UNIT
Power Dissipation Per Segment	70	mW
Peak Forward Current Per Segment ( Frequency 1Khz, 15% duty cycle)	90	mA
Continuous Forward Current Per Segment	25	mA
Forward Current Derating from 25°C	0.28	mA/°C
Reverse Voltage Per Segment	5	V
Operating Temperature Range	-35°C to +105°C	
Storage Temperature Range	-35°C to +105°C	
Soldering Conditions : 1/16 inch below seating plane for 3 seconds at 260°C		

## ELECTRICAL / OPTICAL CHARACTERISTICS AT Ta = 25°C

PARAMETER	SYMBOL	MIN	TYP	MAX	UNIT	TEST CONDITION
Average Luminous Intensity Per Segment	I <sub>v</sub>	320 5400	1300 17000		μcd	I <sub>F</sub> = 1mA I <sub>F</sub> = 10mA
Peak Emission Wavelength	λ <sub>p</sub>		632		nm	I <sub>F</sub> = 20mA
Spectral Line Half-Width	Δλ		20		nm	I <sub>F</sub> = 20mA
Dominant Wavelength	λ <sub>d</sub>		624		nm	I <sub>F</sub> = 20mA
Forward Voltage Per Segment	V <sub>F</sub>		2.1	2.6	V	I <sub>F</sub> = 20mA
Reverse Current Per Segment	I <sub>R</sub>			100	μA	V <sub>R</sub> = 5V
Luminous Intensity Matching Ratio	I <sub>v</sub> -m			2 : 1		I <sub>F</sub> = 1mA

Note: Luminous Intensity is measured with a light sensor and filter combination that approximates the CIE (Commision Internationale De L'Eclairage) eye-response curve.

**TYPICAL ELECTRICAL / OPTICAL CHARACTERISTIC CURVES**

(25°C Ambient Temperature Unless Otherwise Noted)

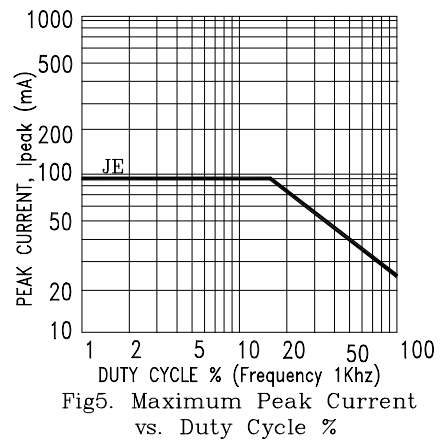
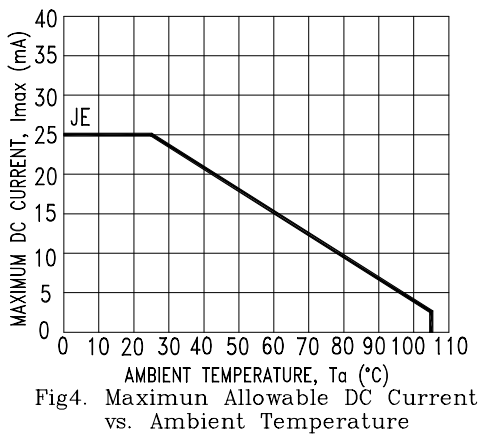
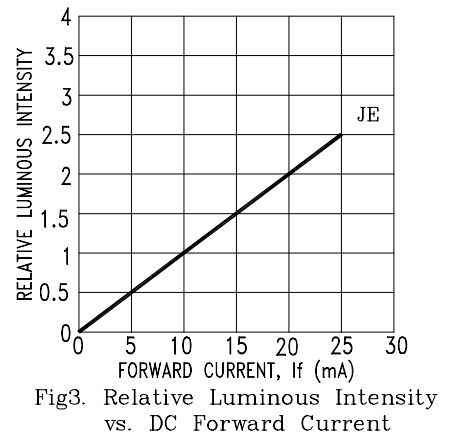
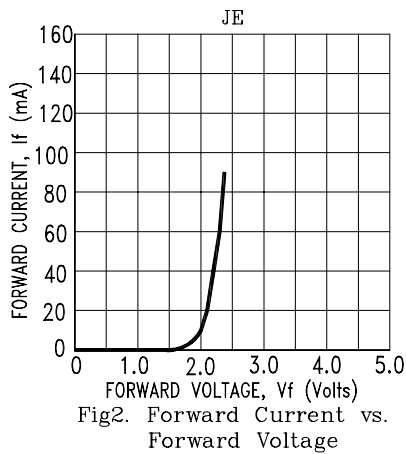
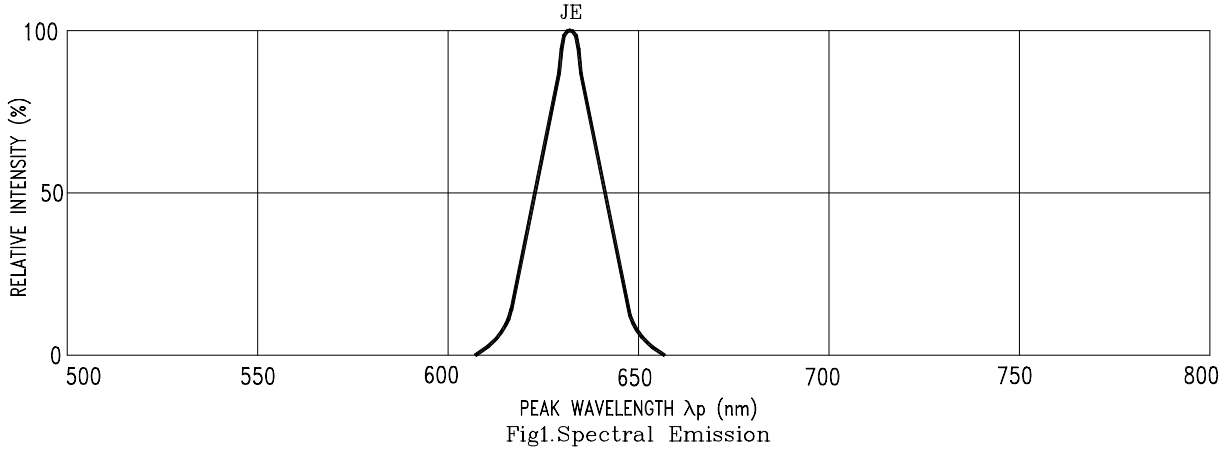

NOTE : JE=AlInGaP RED